

Simultaneous high-speed measurement of internal resistance and battery voltage

## From large-cell to high-voltage battery testing - HIOKI is The Choice

The **BT3563, BT3562, and 3561 BATTERY HiTESTERS** support simultaneous high-speed measurement of internal resistance (IR) and battery voltage (OCV) for the ever-expanding production lines of increasingly larger lithium-ion low resistance batteries, and other battery packs for high voltage applications.

- Measure high-voltage battery packs up to 300V (with the BT3563)
- Ideal for high-precision cell voltage measurements (accurate to 0.01% of reading)
- Measurement circuitry employs enhanced current regulation
- Fast 10 ms response and 8 ms sampling time for high-speed measurements (with the BT3563 and BT3562)
- Ranges from 3 mΩ to 3000 Ω (with the BT3563 and BT3562) support coin-size to large-cell batteries

# Resistance and voltage measurements

## BATTERY HiTESTER BT3563 BT3562 3561



### Measurement Parameters and Applications

- High-voltage battery pack testing
- Battery module testing
- Large (low-resistance) cell testing
- High-speed mass production testing of coin batteries
- Fuel cell stack measurements
- Battery research and development measurement applications

**BT3563**  
Up to  
**300V**

**BT3562**  
Up to  
**60V**



**Voltage measurement ranges:** 6V/60V/300V (BT3563)  
6V/60V (BT3562)

**Resistance measurement ranges:** 3mΩ/30mΩ/300mΩ/  
3Ω/30Ω/300Ω/3000Ω

### Lithium-Ion and Secondary Batteries

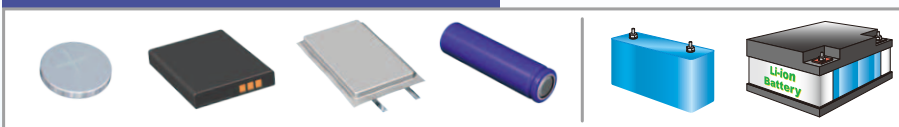

Cell phones



E-books



Electric bicycles



Electric scooters



EV/HEV

### Battery-Powered Devices

### Advanced Functions

#### ● Four-Terminal AC Method

The four-terminal, 1-kHz AC method uses four contact probes to measure resistance independently of that of the measurement leads.

#### ● Measurement Error Detection

Detects test probe contact failure and broken leads, for 100% measurement reliability.

#### ● Self-Calibrating

Minor drift and gain fluctuations within the internal measurement circuitry are automatically corrected to maintain high accuracy.

#### ● Averaging Function

Stable readings can be consistently obtained by averaging two to 16 measurements.

# to confirm finished quality

## ■ Features of Battery HiTester Series

### High Precision

**Resistance**  
 $\pm 0.5\%$  rdg.  $\pm 5$  dgt.  
**Voltage**  
 $\pm 0.01\%$  rdg.  $\pm 3$  dgt.

Common to the BT3563, BT3562 and 3561

### High Resolution

**Resistance:  $0.1 \mu\Omega$ <sup>\*1</sup>**  
**(3 m $\Omega$  range)**  
**Voltage:  $10 \mu\text{V}$ <sup>\*1</sup>**  
**(6 V range)**

<sup>\*1</sup> BT3563 and BT3562

### Quick Response

**Resistance & Voltage**  
**Simultaneous measurements**  
**within 18 ms<sup>\*2</sup>**

<sup>\*2</sup> Sampling time + response time:  
 with EX.FAST sampling  
 BT3563 and BT3562

- The 3 m $\Omega$  range (with  $0.1 \mu\Omega$  resolution) is ideal for testing ever lower-resistance large cells (BT3563 and BT3562).
- The 6 V range (with  $10 \mu\text{V}$  resolution and 0.01% accuracy) is ideal for the high-precision voltage measurements required for cell testing (BT3563 and BT3562).

- Provides high-speed measurement of high-voltage<sup>\*3</sup> battery packs, for improving productivity (BT3563).

<sup>\*3</sup> BT3563: up to 300V  
 BT3562: up to 60V

## ■ Measurement Parameters and Applications

## BATTERY HiTESTER 3561

- For high-speed production line testing of small battery packs for mobile and portable communications devices
- For high-speed production line testing of small cells
- High-speed 10ms inspection in the 300m $\Omega$  and 3 $\Omega$  ranges
- Improve inspection efficiency during mass production of compact cells

**3561**  
 Up to  
**20V**



**Voltage measurement ranges: 20V**

**Resistance measurement ranges: 300m $\Omega$ /3 $\Omega$**

### Lithium-Ion and Secondary Batteries

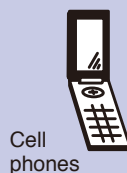
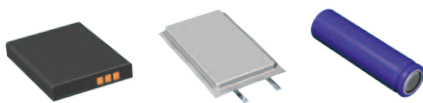

Cell phones



E-books

### Battery-Powered Devices

### Quick Response with small cell measurement

**Resistance & Voltage**  
**Simultaneous measurements**  
**within 10 ms<sup>\*4</sup>**

<sup>\*4</sup> Sampling time + response time:  
 with EX.FAST sampling  
 3561

## Battery HiTester Series

- **Measurement Value Storage**  
 Store up to 400 measurement values by external trigger input, for bulk transfer to a computer.
- **Statistical Calculations**  
 Apply statistical calculations to up to 30,000 data points to facilitate process and quality control.

- **Save Measurement Setting Configurations**  
 Up to 126 measurement configurations such as comparator setting criteria can be saved and reloaded. Saved configurations can be selected by external control.

# Automatic Testing Lines

## High Speed Interfaces

The fastest 10 ms measurement data can be transferred via the standard RS-232C interface at up to 38,400 bps.

Models with the -01 suffix include a GP-IB interface.

## Handler Interface

Triggering, measurement configuration loading, and zero adjustment can be externally controlled. Output signals provide comparator results, end-of-measurement events, and measurement errors. (Because the BT3563/BT3562 are different from the 3561, consult each model's Instruction Manual for specific details or designs.)

BT3563, BT3562 and 3561 External I/O Items	
Input (no-voltage contacts <sup>*1</sup> )	Output (open collector <sup>*1</sup> )
<ul style="list-style-type: none"> <li>Measurement trigger (TRIG)</li> <li>Print (PRINT)</li> <li>Zero adjustment (OAJ)</li> <li>Calibrate (CAL)</li> <li>Manual comparator (MANU)</li> <li>Load panel settings (7 bits) (LOAD0 to LOAD6)</li> </ul>	<ul style="list-style-type: none"> <li>End-of-Measurement (EOM)</li> <li>Measurement-in-progress (INDEX)</li> <li>Comparator results (R-Hi, R-IN, R-Lo, V-Hi, V-IN, V-Lo, PASS, FAIL<sup>*2</sup>)</li> <li>Measurement error (ERR)</li> <li>General-purpose output (OUT1 to OUT9) (only 3561)</li> </ul>

<sup>\*1</sup> The input and output signals of the BT3563 and BT3562 are isolated via photocouplers.

### EXT I/O Connectors (BT3563 and BT3562, accessories not supplied)

Installed connector (HiTester side): 37-pin D-SUB accepts #4-40 screws  
 Mating connectors: DC-37P-ULR (solder type) or DCSP-JB37PR (welded type) from Japan Aviation Electronics Industry, Ltd., or equivalent

### EXT I/O Connectors (3561, accessories not supplied)

Installed connector (HiTester side): 57RE-40360-730B (D29) (DDK)  
 Mating connectors: 57-30360 (DDK), RC30-36P (Hirose Electric Co., Ltd.), or equivalent

BT3563-01 and BT3562-01 Rear Panel

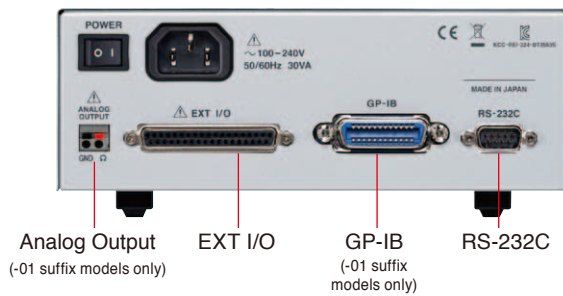

3561-01 Rear Panel

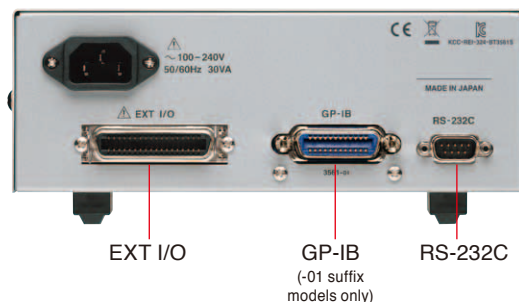

### BT3563 and BT3562 External I/O Timing Chart

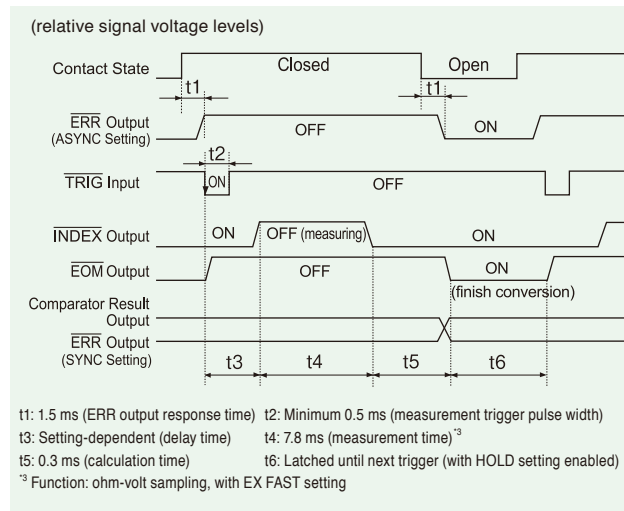

## Comparator Functions

### Judges Resistance & Voltage Simultaneously

Resistance and voltage can be simultaneously judged Hi/IN/Lo by independent comparators. Judgment results are provided on the display, beeper, and external I/O. The display allows confirming both results at a glance.



Resistance comparator settings



Voltage comparator settings



### Composite Judgment Result Output

External I/O provides both separate and combined outputs of resistance and voltage judgment results, so composite results can be monitored.

### Alternative Setting Methods

Set judgment thresholds by specifying high/low (Hi/Lo) values or by specifying a standard value and deviation (%).

### Manual Comparator

Comparator judgments can be executed only when required, supporting flexible control by footswitch or PLC.

### Dual Beep Tones

Different beep tones distinguish IN and Hi/Lo judgments. Both tones can be independently enabled or disabled.

# Multiple Recording Methods

## ■ Analog Output (BT3563-01 and BT3562-01 only)

The BT3563-01 and BT3562-01 provide analog output of resistance measurement values. This is convenient for combining recorded data from multiple locations or of various data types, such as for logging long-term measurements and for fuel cell evaluation.

Output contents	Measured resistance (displayed value)
Output rate	0 to 3.1 V DC (corresponding to displayed value of 0 to 31000)
Resolution	12 bits
Response time	10 ms



## ■ PC Application Program

Measurement data can be transferred to a PC for importing to a spreadsheet program or storage as CSV files. Interval and manual measurements can be triggered by a keystroke or external trigger signal.

Download the PC application program from our website:

<http://www.hioki.com/>

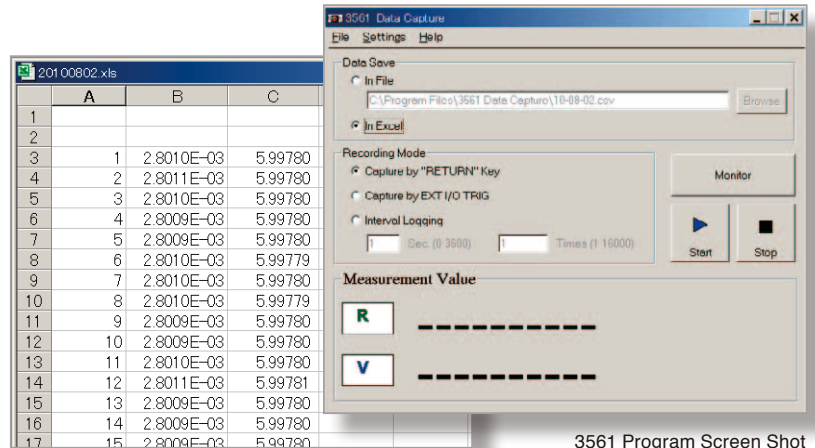

Excel Import Example

3561 Program Screen Shot

## ■ Data Printing

Measurement values, and those including judgment results and statistical calculation results can be printed using an RS-232C-compatible printer.

### ● Interval Printing

Elapsed time and measurement values can be printed over a specified interval. The interval can be set from 1 to 3,600 seconds.

### ● Requirement specification (printer)

The requirements for a printer to be connected to the instrument are as follows. Confirm compatibility and make the appropriate settings on the printer before connecting it to the instrument.

Interface	: RS-232C
Characters per line	: At least 40
Communication speed	: 9600 bps
Data bits	: 8
Parity	: none
Stop bits	: 1
Flow control	: none

BT3563/BT3562/3561  
(9-pin) Connector

Function	Signal name	Pin
Receive Data	R x D	2
Transmit Data	T x D	3
Signal or Common Ground	GND	5

ASCII data will be sent from the BT3563/BT3562/3561. Please use a printer that can output plain text.

For the RS-232C cable, the connector at the instrument end should be a molded type. The metal type (with hooks preventing the surface from being flat) will not fit due to the instrument's design.

### Printout Examples

```

1 2.5375mOhm, 4.70056 V
2 - 0.9730mOhm, 4.70055 V
3 0.F. , 0.F.
4 -----, -----
5 15.039 Ohm, - 50.254 V
6 200.12 Ohm, 11.3176 V
7 2.9984kOhm, -11.3099 V
8 0.1615 Ohm, -4.70054 V
9 0.166 Ohm, - 4.7006 V
10 0.16 Ohm, - 4.700 V
    
```

Measurement Values

```

50 5.033 Ohm Hi, 1.60427 V
51 5.033 Ohm Hi, -0.00001 V
52 17.865mOhm IN
53 18.354mOhm Hi
54 15.322mOhm Lo
    
```

Measurement Values and Judgment Results

```

*** RESISTANCE ***
Number      85
Valid       85
Average     13.06 Ohm
Max         13.78 mOhm ( 74)
Min         12.10 mOhm ( 3)
Sn          0.38mOhm
Sn-1        0.38mOhm
Op          1.32
CqK         0.09
Comp Hi     40
Comp IN     45
Comp Lo     0

*** VOLTAGE ***
Number      85
Valid       85
Average     10.0074 V
Max         10.0197 V ( 57)
Min         9.9938 V ( 31)
Sn          0.0068 V
Sn-1        0.0068 V
Op          0.35
CqK         0.32
Comp Hi     10
Comp IN     59
Comp Lo     16
    
```

Statistical Calculations and Judgment Results

## ■ Specifications

### ● BT3563, BT3562 and 3561 Specifications

Measurement types	Resistance and voltage
Resistance measurement method	Four-terminal AC (1 kHz) method
Functions	$\Omega$ V, $\Omega$ and V
Rated voltage	[BT3563(-01)] ±300 VDC rated input voltage ±300 VDC maximum rated voltage to ground [BT3562(-01)] ±60 VDC rated input voltage ±70 VDC maximum rated voltage to ground [3561(-01)] ±22 VDC rated input voltage ±70 VDC maximum rated voltage to ground
Input resistance	[BT3563(-01) and BT3562(-01)] 3 m $\Omega$ /30 m $\Omega$ /300 m $\Omega$ ranges: Approx. 90 k $\Omega$ 3 $\Omega$ /30 $\Omega$ /300 $\Omega$ /3000 $\Omega$ ranges: Approx. 1 M $\Omega$ [3561(-01)] Approx. 1M $\Omega$
Sampling rate	Four steps – Extra Fast, Fast, Medium or Slow
Response time	[BT3563(-01) and BT3562(-01)] Approx. 10 ms for measurements Note: Response time depends on reference values and the measurement object. [3561(-01)] Approx. 3 ms for measurements Note: Response time depends on reference values and the measurement object.
Total measurement time	Sampling time + Response time

Zero-adjustment	1000 count range (both resistance and voltage)
Triggering	Internal or external
Delay time	On/off, 0 to 9.999 seconds
Averaging samples	On/off, 2 to 16 samples
Statistical calculations	Total data count; valid data count; maximum, minimum and average values; standard deviation; population standard deviation and process capability indices
Measurement value output function	Measurement values are output via RS-232C upon trigger input
Measurement value memory	Up to 400 measurements
Panel save/load	Up to 126 configuration settings Save Frequently Used Settings in Memory: Measurement function, resistance measurement range, auto-range setting, zero-adjust setting data, sampling rate, trigger source, delay setting, averaging and comparator settings, statistical calculation setting, display switching and key-lock.
Analog Output	[BT3563-01 and BT3562-01 only] Measured resistance (displayed value, from 0 to 3.1 VDC)
External interface	External I/O, RS232C (9600, 19200 or 38400 bps), Printer RS-232C (all models), GP-IB (Model BT3563-01, BT3562-01 and 3561-01 only)
Other functions	Over-range display, measurement error detection, self-calibration, dual comparators, key-lock

### ● BT3563, BT3562 and 3561 General Specifications

Operating temperature & humidity	0 to 40°C, 80% rh or less (non-condensating)
Storage temperature & humidity	-10 to 50°C, 80% rh or less (non-condensating)
Guaranteed accuracy temperature & humidity	23°C ±5°C, 80% rh or less (non-condensating)
Operating conditions	Indoors, below 2000 m ASL
Rated supply voltage	100 to 240 VAC (auto-selecting)
Rated supply frequency	50/60 Hz
Rated power consumption	30 VA

Insulation withstand potential	[BT3563(-01), BT3562(-01)] 1.39 kV AC for 15 s (with 10 mA cut-off current) between all mains supply terminals and protective ground terminal 2.224 kV AC for 15 s (with 1 mA cut-off current) between all measurement jacks and interfaces 1.39 kV AC for 15 s (with 1 mA cut-off current) between all measurement jacks and protective ground terminal [3561(-01)] 1.69 kVAC for 15 s (with 10 mA cutoff current) between all mains supply terminals and protective ground, interfaces, and measurement jacks
Dimensions	Approx. 215W × 80H × 295D mm (without projections)
Mass	Approx. 2.4 kg
Accessories	Power Cord (1)
Applicable Standards	Safety EN61010-1 EMC EN61326 EN61000-3-2 EN61000-3-3

### ● BT3563 and BT3562

#### [ Sampling Times ]

Function		EX.FAST	FAST	MEDIUM	SLOW
$\Omega$ V	(50 Hz)	8 ms	24 ms	84 ms	259 ms
	(60 Hz)			70 ms	253 ms
$\Omega$	(50 Hz)	4 ms	12 ms	42 ms	157 ms
	(60 Hz)			35 ms	150 ms
V	(50 Hz)	4 ms	12 ms	42 ms	157 ms
	(60 Hz)			35 ms	150 ms

Items in the parentheses ( ) indicate supply frequency settings; Tolerance: ±5 ms for SLOW sampling, and ±1 ms for other settings.

### ● 3561

Function		EX.FAST	FAST	MEDIUM	SLOW
$\Omega$ V	(50 Hz)	7 ms	23 ms	83 ms	258 ms
	(60 Hz)			69 ms	252 ms
$\Omega$	(50 Hz)	4 ms	12 ms	42 ms	157 ms
	(60 Hz)			35 ms	150 ms
V	(50 Hz)	4 ms	12 ms	42 ms	157 ms
	(60 Hz)			35 ms	150 ms

Items in the parentheses ( ) indicate supply frequency settings; Tolerance: ±5 ms for SLOW sampling, and ±1 ms for other settings.

## Measurement Ranges and Accuracy (Accuracy guaranteed for 1 year, Post-adjustment accuracy guaranteed for 1 year)

### ● BT3563, BT3562 and 3561 Conditions of Guaranteed Accuracy

Temperature & humidity:

23 °C ±5 °C, 80% rh or less (non-condensating)

Zero-adjustment: After executing zero-adjustment

Warm-up time: At least 30 min.

Self-calibration:

Unless using SLOW sampling, execute self-calibration after warm-up and restrict temperature fluctuations to within ±2 °C after calibration.

### ● About Accuracy

Accuracy is calculated from the reading error (±% rdg.) determined by the measurement value and range, and the digit error (± dgt.).

#### Calculation Example

Measurement value: 1 Ω, Measurement range: 3 Ω

Specified accuracy (from table below): ±0.5% rdg., ±5 dgt.

(A) Reading error (±% rdg.): 1 [Ω] × 0.5% = ±0.005 [Ω]

(B) Digit error (± dgt.): ±5 dgt. = ±0.0005 [Ω] (at 0.0001 Ω resolution)

(C) Total error (A + B): ±0.0055 [Ω]

Applying total error (C) to the measurement value of 1 Ω gives an error limit of 0.9945 to 1.0055 Ω.

### ● BT3563 and BT3562 [Resistance Measurement]

Range	3 mΩ	30 mΩ	300 mΩ	3 Ω	30 Ω	300 Ω	3000 Ω
Maximum display Value	3.1000 mΩ	31.000 mΩ	310.00 mΩ	3.1000 Ω	31.000 Ω	310.00 Ω	3100.0 Ω
Resolution	0.1 μΩ	1 μΩ	10 μΩ	100 μΩ	1 mΩ	10 mΩ	100 mΩ
Measurement Current <sup>*1</sup>	100 mA	100 mA	10 mA	1 mA	100 μA	10 μA	10 μA
Measurement Current Frequency	1 kHz ±0.2 Hz						
Accuracy <sup>*2</sup>	±0.5% rdg. ±10 dgt.		±0.5% rdg. ±5 dgt.				
Temperature coefficient	(±0.05% rdg. ±1 dgt.) / °C		(±0.05% rdg. ±0.5 dgt.) / °C				
Open-Circuit Voltage	25 Vpeak		7 Vpeak	4 Vpeak			

\*1 Measurement current accuracy is ±10%.

\*2 30 mΩ to 3000 Ω ranges: Add ±3 dgt. for EX FAST, or ±2 dgt. for FAST and MEDIUM  
3mΩ range: Add ±30 dgt. for EX FAST, or ±10 dgt. for FAST, or ±5 dgt. for MEDIUM

### [Voltage Measurement]

Range	6 V	60 V	300 V (only BT3563)
Maximum display Value	±6.00000 V	±60.0000 V	±300.000 V
Resolution	10 μV	100 μV	1 mV
Accuracy <sup>*3</sup>	±0.01% rdg. ±3 dgt.		
Temperature coefficient	(±0.001% rdg. ±0.3 dgt.) / °C		

\*3 Add ±3 dgt. for EX FAST, or ±2 dgt. for FAST and MEDIUM

### ● 3561 [Resistance Measurement]

Range	300 mΩ	3 Ω
Maximum display Value	310.00 mΩ	3.1000 Ω
Resolution	10 μΩ	100 μΩ
Measurement Current <sup>*4</sup>	10 mA	1 mA
Measurement Current Frequency	1 kHz ±0.2 Hz	
Accuracy <sup>*5</sup>	±0.5% rdg. ±5 dgt.	
Temperature coefficient	(±0.05% rdg. ±0.5 dgt.) / °C	
Open-Circuit Voltage	7 Vpeak	

\*4 Measurement current accuracy is ±10%.

\*5 Add ±3 dgt. for EX FAST, or ±2 dgt. for FAST and MEDIUM

\*6 Add ±3 dgt. for EX FAST, or ±2 dgt. for FAST and MEDIUM

### ● 3561 [Voltage Measurement]

Range	20V
Maximum display Value	±19.9999 V
Resolution	0.1 mV
Accuracy <sup>*6</sup>	±0.01% rdg. ±3 dgt.
Temperature coefficient	(±0.001% rdg. ±0.3 dgt.) / °C

# Main unit

**Model : BATTERY HiTESTER BT3563**  
 Model No. (Order Code) (Note)  
**BT3563**  
**BT3563-01** (Built in GP-IB and analog output)

**Model : BATTERY HiTESTER BT3562**  
 Model No. (Order Code) (Note)  
**BT3562**  
**BT3562-01** (Built in GP-IB and analog output)

**Model : BATTERY HiTESTER 3561**  
 Model No. (Order Code) (Note)  
**3561**  
**3561-01** (Built in GP-IB interface)



- Measurement leads are not included. Purchase the appropriate lead option for your application separately.
- The male (system side) of the EXT I/O connector is also available. Please inquire with your HIOKI distributor.

## Options (measurement leads)

### Measurement lead (for measuring high voltage batteries with Models BT3563 and BT3562)



**PIN TYPE LEAD L2110**  
 A:750 mm (29.53 in), B:215 mm (8.46 in), L:1880 mm (9.17 ft), for high voltage battery measurements, 1000 V DC max.

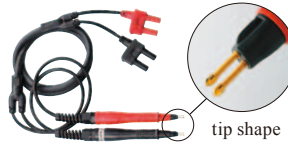

**PIN TYPE LEAD L2100**  
 A:300 mm (11.81 in), B:172 mm (6.77 in), L:1400 mm (4.59 ft), for high voltage battery measurements, 1000 V DC max.

### Zero adjustment board (for L2110, L2100 only)



**0 ADJ BOARD Z5038**  
 For L2110, L2020, 9465-10, 9772

Cannot be used for zero adjusting the 9770 and 9771 Pin Type Leads

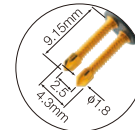

For tip replacement (Common to L2110, L2100)

**TIP PIN 9772-90**  
 To replace the tip on the Pin type lead 9772, L2100/L2110, (one piece)

### Measurement leads (for measuring batteries up to 60 V with BT3563, BT3562, or 3561)



**CLIP TYPE LEAD L2107**  
 A:130 mm (5.12 in), B:83 mm (3.27 in), L:1100 mm (3.61 ft), 70 VDC



**FOUR TERMINAL LEAD 9453**  
 A:280 mm (11.02 in), B:118 mm (4.65 in), L:1360 mm (4.46 ft), 60V DC



**LARGE CLIP TYPE LEAD 9467**  
 A: 300 mm (11.81 in), B: 131 mm (5.16 in), L: 1310 mm (4.30 ft), tip  $\phi$  29 mm (1.14 in), 50 V DC

### Mainly for Small Secondary Batteries (with very small terminals)

1.8 mm dia. single-axis type for measuring small electrodes

0.2 mm parallel pyramid-type pins for measuring at thru holes and sub-millimeter objects

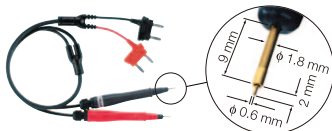

**PIN TYPE LEAD 9770** 9770 tip shape  
 A:260 mm (10.24 in), B:140 mm (5.51 in), L:850 mm (2.79 ft), 70V DC

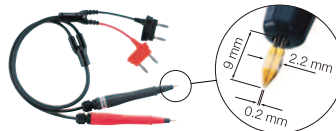

**PIN TYPE LEAD 9771** 9771 tip shape  
 A:260 mm (10.24 in), B:138 mm (5.43 in), L:850 mm (2.79 ft), 70V DC

### Measurement leads (3561 only)



**CLIP TYPE LEAD 9452**  
 A:220 mm (8.66 in), B:197 mm (7.76 in), L:1360 mm (4.46 ft)

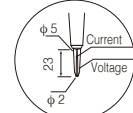

9452 tip shape

### Measurement leads (for maximum precision, 3561 only)

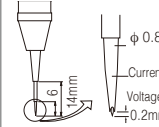

**PIN TYPE LEAD 9455**  
 A:260 mm (10.24 in), B:136 mm (5.35 in), L:890 mm (2.92 ft), Not CE marked.  
 Note: The 9455 is a precision instrument. Exercise appropriate care when handling it.

### About probe length

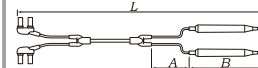

A: From junction to probe  
 B: Probe part  
 L: Whole length

## Options (Interface Cables)

### Interface (RS-232C and GP-IB) Connection cables



**RS-232C CABLE 9637**  
 For the PC, 9pin - 9pin, cross, 1.8m (5.91 ft) length



**GP-IB CONNECTOR CABLE 9151-02**  
 2 m (6.56 ft) length

Note: Company names and Product names appearing in this catalog are trademarks or registered trademarks of various companies.

**HIOKI**  
 HIOKI E. E. CORPORATION

**HEADQUARTERS**  
 81 Koizumi,  
 Ueda, Nagano 386-1192 Japan  
<https://www.hioki.com/>



Our regional contact information

DISTRIBUTED BY